

VISION galler

gallerpinnar 1100

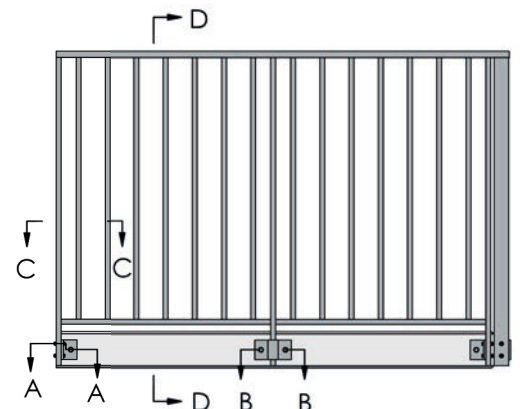

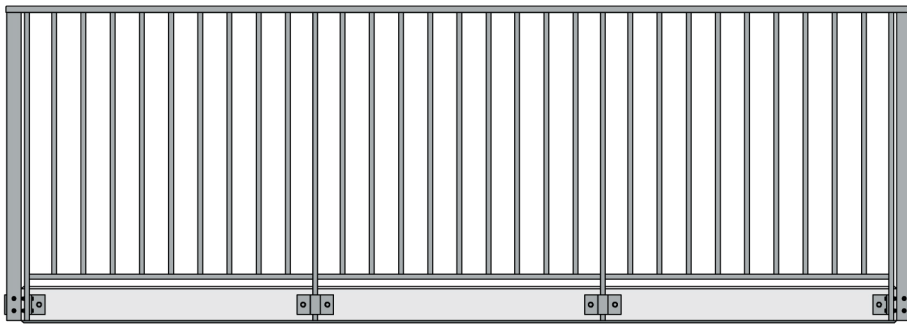

Handledare

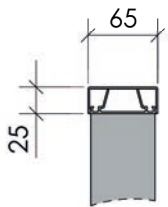

P 65

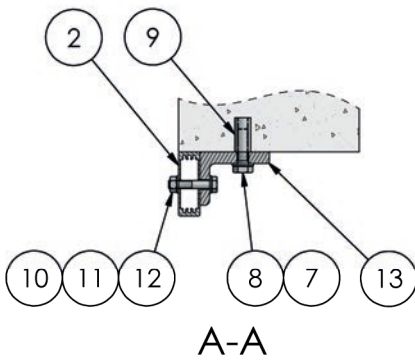

A-A

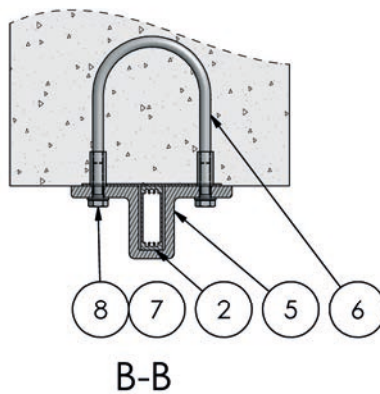

B-B

Alternativa typer av infästning är kemankare i betong, svetsfäste på stålbalk och stolpfot för infästning ovanifrån.

- | | |
|----------------------|------------------------|
| 1 Handledare P65 | 7 Bricka 20/10,5 rfr |
| 2 Räckesstolpe 60x20 | 8 Bult M10x35 rfr |
| 3 Gallerpinne R20 | 9 Gänghylsa M10 |
| 4 Undeliggare | 10 Bricka 16/8,5 rfr |
| 5 Stolphållare | 11 Bult M8x40 rfr |
| 6 Ingjutningsbygel | 12 Mutter M8 rfr |
| | 13 Stolphållare vinkel |

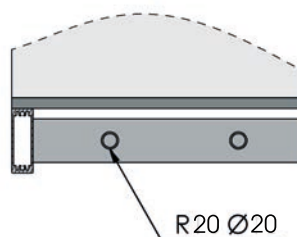
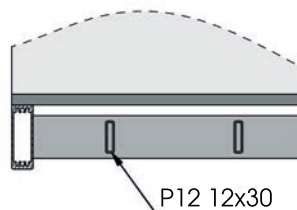
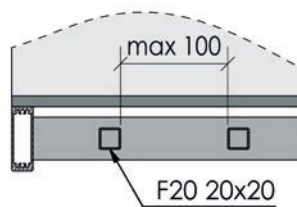

C-C

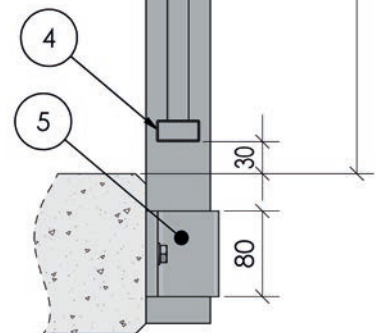
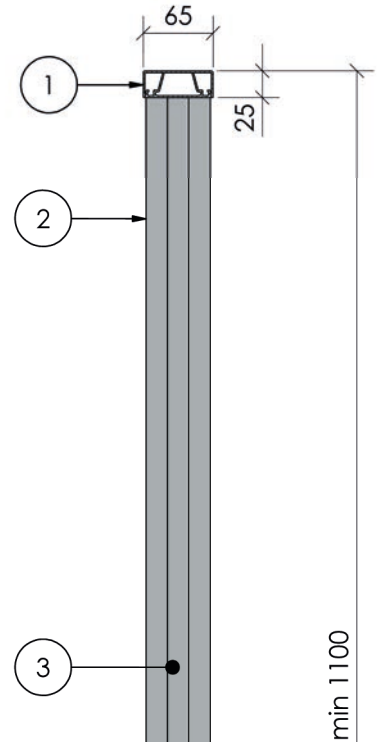

D-D



Arqdesign Byggprodukter AB
Box 18
573 21 TRANÅS

Tel: 0140-38 61 00
info@arqdesign.se

Fax: 0140-38 61 10
www.arqdesign.se

VISION galler
gallerpinnar 1100